

Dual Solenoid Gas Valve

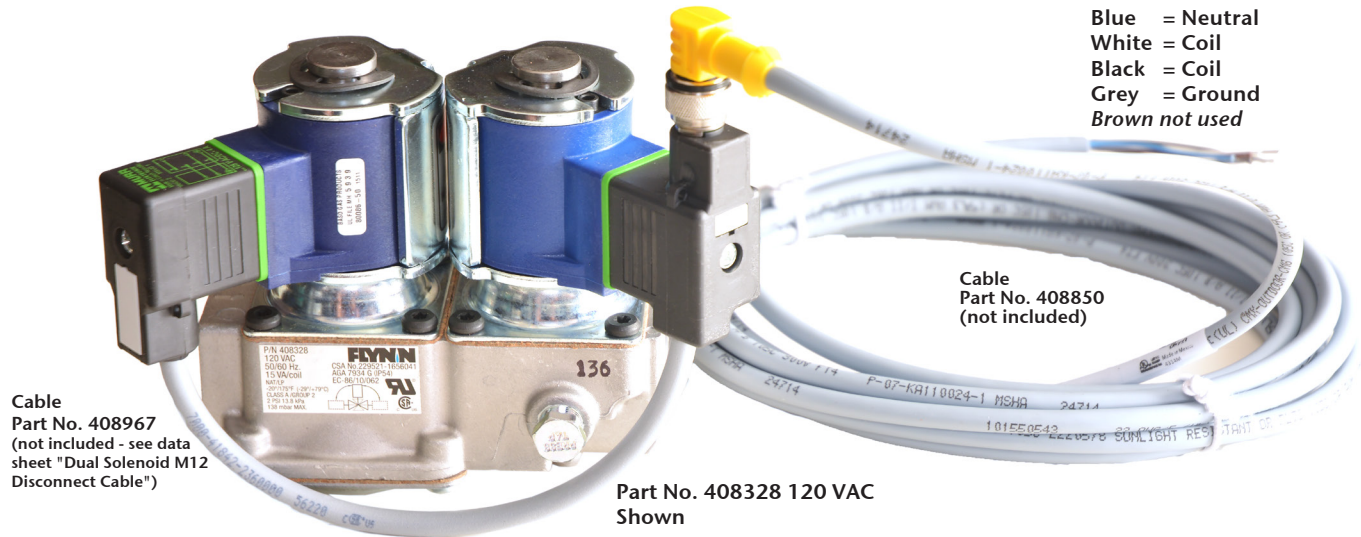

Cable
Part No. 408967
(not included - see data
sheet "Dual Solenoid M12
Disconnect Cable")

Cable
Part No. 408850
(not included)

Part No. 408328 120 VAC
Shown

Description

The Flynn Dual Solenoid Gas Valve consists of 2 solenoid valves in 1 body. The Flynn Dual Solenoid Gas Valve can be used with any clean gaseous fuel, natural gas, propane, butane, LPG, LNG, etc, at pressures up to 2 PSIG.

Specifications

3/8" & 1/2" NPT/BSPP

Maximum inlet pressure is 2 PSIG

Permissible ambient (surface) temperature is -20 to 175°F (-29 to 79°C)

24 VAC, 120 VAC, 240 VAC

Agency Listing

UL Approved

CSA (AA/CGA) Certificate Number 23226265

EC Type Examination Certificate Number EC-86/10/062/M16

Other

Meets dual solenoid valve requirement of NFPA 86 for inputs ≤ 150,000 BTU/HR & Canadian Standard CAN I-6.5

Selection Chart

Part Number	Inlet & Outlet	VAC (50/60 Hz)
408 329	3/8" x 3/8" NPT	24 VAC
408 328	3/8" x 3/8" NPT	120 VAC
408 311	3/8" x 3/8" NPT	240 VAC
408 130	3/8" x 3/8" BSPT	24 VAC
408 129	3/8" x 3/8" BSPT	120 VAC
408 519	3/8" x 3/8" BSPT	240 VAC
408 321	1/2" x 1/2" NPT	24 VAC
408 040	1/2" x 1/2" NPT	120 VAC

Dual Solenoid Gas Valve

Dimensions

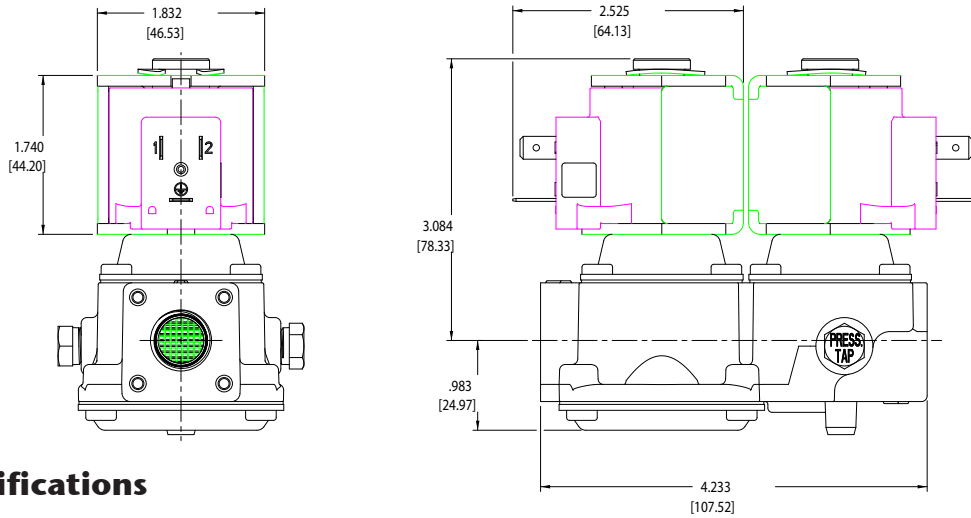

Technical Specifications

Types of Gas	2nd (Natural Gas), and 3rd (LP Gas) Family Gases
Permissible Ambient (Surface) Temperature	-20 to 175°F (-29 to 79°C)
Electrical Ratings	24 VAC, 50/60 Hz, 0.595A 120 VAC, 50/60 Hz, 0.13A 240 VAC, 50/60 Hz, 0.063A
Maximum Operating Pressure	North America: 2 ps i Europe: 138 mbar
Reverse Pressure Ratings	150 mbar (15 kPa) (60 in. W.C.); Class A (EN 161)
Inlet Pipe Size	3/8 in. NPT or 1/2 in. NPT, 3/8 BSPP or 1/2 BSPP
Outlet Pipe Size	3/8 in. NPT or 1/2 in. NPT, 3/8 BSPP or 1/2 BSPP
Valve Torsion Group	Group 2 (EN 161)
Pressure Connection	1/8 in. NPT or M5 x 0.8 thread bottom
Dirt Strainer	0.9 mm (0.035 in.) Mesh
Operating Time Rating	100% Continuous
Valve Timings Power Rating	Closing Time: ≤ 1 Second Opening Time: ≤ 1 Second Dead Time: < 1 Second
Power Rating	15 VA per Coil
Agency Listings	UL Listed CSA Certificate Number 23226265 EC Type Examination Certificate Number EC-86/10/062/M16
Specification Standards	EN 161 Standards Complying with the EMC Directive Standards Complying with the Low Voltage Directive ANSI Standards Z21.21 Canadian Standard CSA 6.5 EC Certificate EC-86/10/062/M16

Dual Solenoid Gas Valve



Dual Valve Requirement of the 2015 edition of NFPA 86 Standards - *Ovens & Furnaces*- Section 8.8.2, 8.8.2.1 and A.8.8.2

8.8.2* Fuel Gas Safety Shutoff Valves.

8.8.2.1 Each main and pilot fuel gas burner system shall be separately equipped with either of the following:

- (1) Two safety shutoff valves piped in series
- (2) For radiant tube-fired burner systems only, a single safety shutoff valve where either of the following conditions is satisfied:
 - (a) The tubes are of metal construction and open at one or both ends with heat recovery systems, if used, that are of explosion-resistant construction.
 - (b) The entire radiant tube heating system, including any associated heat recovery system, is of explosion-resistant construction.

A.8.8.2 (from NFPA-86 2011)

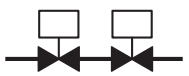
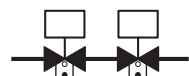
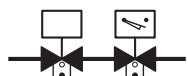
Key	Safety shutoff valve requirements		
Safety shutoff valve  Safety shutoff valve with visual identification and proof of closure 	Under 150,000 Btu/hr 	150,000 to 400,000 Btu/hr 	Over 400,000 Btu/hr 

Reproduced with permission from NFPA 86, *Ovens & Furnaces*, Copyright© 2015, National Fire Protection Association. This reprinted material is not the complete and official position of the NFPA on the referenced subject, which is represented only by the standard in its entirety.

FLYNN BURNER DUAL SOLENOID VALVE INSTALLATION INSTRUCTIONS

Installation

IMPORTANT: These instructions are intended as a guide for qualified personnel installing or servicing equipment. Carefully follow all instructions in this bulletin and all instructions on the appliance. Limit repairs, adjustments, and servicing to the operations listed in this bulletin or on the appliance.



WARNING: Risk of Fire or Explosion.

The system must meet all applicable local, national, and regional regulations. Improper installation may cause gas leaks, explosions, property damage, and injuries.



WARNING: Risk of Fire or Explosion.

To prevent leakage of upstream gas, shut off the gas supply at the main manual shutoff valve before installing or servicing the dual solenoid valve. Failure to shut off the gas supply can result in the release of gas during installation or servicing, which can lead to an explosion or fire, and may result in severe personal injury or death.

Mounting



CAUTION: Risk of Equipment Damage. To prevent damage to the valve when mounting to pipework, do not use a wrench on any surface other than the casting flats provided at the inlet and outlet ends of the valve body.

To install the dual solenoid valve:

1. Ensure that the specified maximum ambient (surface) temperature is not exceeded 175 degrees Fahrenheit.
2. Ensure that the power supply voltage is compatible with the required control valve voltage.
3. When installing the valve on the manifold, ensure that the gas flows through the valve body in the direction indicated by the arrow on the valve body. If the valve is installed with the gas flow in the opposite direction of the arrow, leakage can occur.
4. Shut off the gas at the main manual shutoff valve.
5. Mount the valve to the pipework. The dual solenoid valve may be mounted on a horizontal manifold with the solenoid coils pointed up (vertical) or in any position not exceeding 90° from the vertical. The valve also may be mounted on a vertical manifold in any position around its axis (see Figure 1). **Do not** install the solenoid coil upside down. Install vertically wherever possible.

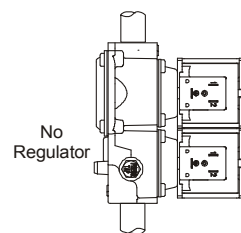
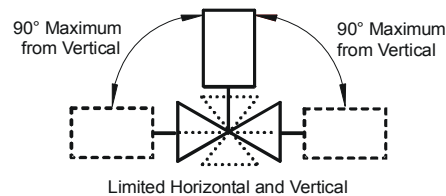

Figure 1: Flynn Dual Solenoid Valve Mounting Positions